

LI65+

Outdoor multi-sensor

thermokon[®]
HOME OF SENSOR TECHNOLOGY

Datasheet

Subject to technical alteration
Issue date: 05.03.2025 • A140



» APPLICATION

Outdoor sensor measuring light, temperature, humidity and atmospheric pressure typically used in lighting applications to optimise energy efficiency through lighting control. The device is designed for outdoor areas, greenhouses, warehouses or industrial halls. The device has an integrated ambient light sensor with precise optical filtering adapted to the human eye. The devices with relay outputs for a 2-point controller or a 2-stage 2-point controller allow for a wide range of applications. Depending on the model, the sensor can be individually configured via Thermokon USEapp. Tool-free opening, closing and wiring as well as removable cable entries ensure quick and easy installation.

» TYPES AVAILABLE

Outdoor sensor light (active)

- Li65+ V
- Li65+ A
- 0..10 V
- 4..20 mA

Outdoor sensor light + temperature (active)

- Li65+ VV
- Li65+ AA
- 2x 0..10 V
- 2x 4..20 mA

Outdoor sensor light + temperature + humidity + atmospheric pressure (opt.) (active)

- Li65+ 3xV
- Li65+ 4xV
- 3x 0..10 V
- 4x 0..10 V

Outdoor sensor light + temperature (active)

- Li65+ VV Relay
- 2x 0..10 V + Relay

» SECURITY ADVICE – CAUTION

The installation and assembly of electrical equipment should only be performed by authorized personnel.



The product should only be used for the intended application. Unauthorised modifications are prohibited! The product must not be used in relation with any equipment that in case of a failure may threaten, directly or indirectly, human health or life or result in danger to human beings, animals or assets. Ensure all power is disconnected before installing. Do not connect to live/operating equipment.

Please comply with

- Local laws, health & safety regulations, technical standards and regulations
- Condition of the device at the time of installation, to ensure safe installation
- This data sheet and installation manual

» PRODUCT TESTING AND CERTIFICATION



Declaration of conformity

The declaration of conformity of the products are available on our website
<https://www.thermokon.de/direct/en-gb/categories/li65plus>

» NOTES ON DISPOSAL



The crossed-out wheeled bin symbol indicates that the product or removable batteries must not be disposed of with household or commercial waste. Within the EU, you are legally obliged to dispose of the product separately and appropriately in accordance with the national laws of your country. Alternatively, please contact your supplier or Thermokon Sensortechnik GmbH. Further information can be found at: www.thermokon.com

» BUILD-UP OF SELF-HEATING BY ELECTRICAL DISSIPATIVE POWER

Sensors with electronic components always have a dissipative power, which affects the temperature measurement of the ambient air. The dissipation in active temperature sensors shows a linear increase with rising operating voltage. This dissipative power has to be considered when measuring temperature. In case of a fixed operating voltage ($\pm 0,2$ V) this is normally done by adding or reducing a constant offset value.

Thermokon transducers can be operated with variable operating voltages. The transducers are set at the factory with a reference operating voltage of 24 V =.

At this voltage, the expected measuring error of the output signal will be the least. Other operating voltages, can cause a measurement deviation changing power loss of the sensor electronics.

A recalibration can be carried out directly on the unit or via a software variable (app or bus).

Remark: Occurring draught leads to a better carrying-off of dissipative power at the sensor. Thus temporally limited fluctuations might occur upon temperature measurement.

» APPLICATION NOTICE FOR HUMIDITY SENSORS

Refrain from touching the sensitive humidity sensor/element. Touching the sensitive surface will void warranty.

For standard environmental conditions re-calibration is recommended once a year to maintain the specified accuracy.

When exposed to high ambient temperature and/or high levels of humidity or presence of aggressive gases (i.e. chlorine, ozone, ammonia) the sensor element may be affected and re-calibration may be required sooner than specified. Re-calibration and deterioration of the humidity sensor due to environmental conditions are not subject of the general warranty.

» TECHNICAL DATA

Measuring values	temperature, light, humidity, atmospheric pressure	
Output voltage	1..4x 0..10 V or 0..5 V (adjustable via jumper; live-zero configuration via Thermokon USEApp), min. load 10 k Ω	
Output ampere <i>(type-dependent)</i>	A AA 1x/2x 4..20 mA, max. load 500 Ω	
Output switch contact <i>(type-dependent)</i>	Relay 2 floating contacts for 24 V ~ or 24 V = / 3 A	
Power supply	V WV 15..35 V = or 19..29 V ~ SELV	A AA 15..35 V = SELV
Power consumption	typ. 0,6 W (24 V =) 1,5 VA (24 V ~)	
Measuring range temp.	adjustable at the transducer: -30..+130 0..+100 0..+150 0..+250 +30..+480 +40..+90 +40..+140 +40..+240, default setting: -30..+130 $^{\circ}$ F	
Measuring range humidity	0..100% rH non-condensing, (optional)	
Measuring range light	0..200 Lux 0..1000 Lux (default) 0..2 kLux 0..10 kLux 0..20 kLux 0..50 kLux, selectable at the device	
Measuring range atm. Pressure	500..1500 hPa, (optional)	
Accuracy temperature	$\pm 0,5$ K (typ. at 70 $^{\circ}$ F)	
Accuracy humidity	$\pm 2\%$ between 10..90% rH (typ. at 70 $^{\circ}$ F)	
Accuracy light	typ. $\pm 5\%$ of measuring range	
Sensor	Ambient light sensor with precise optical filtering appropriate to the human eye	
Enclosure	enclosure USE-M, PC, pure white, cover PC, translucent	
Protection	IP65 according to EN 60529	
Cable entry <i>(type-dependent)</i>	V(V) A(A) 3xV 4xV Flextherm M20, for wire $\varnothing=0.18..0.35$ in., removable	Relay M25 with fourfold cable entry for wire with max. $\varnothing=0.28$ in., removable
Connection electrical	removeable plug-in terminal, max. 14 AWG	
Ambient condition	-22..+158 $^{\circ}$ F, max. 85% rH short term condensation	

Spectral Response: The OPT3001 and Human Eye

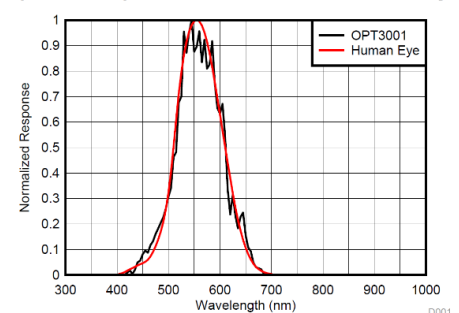

» MOUNTING ADVICES



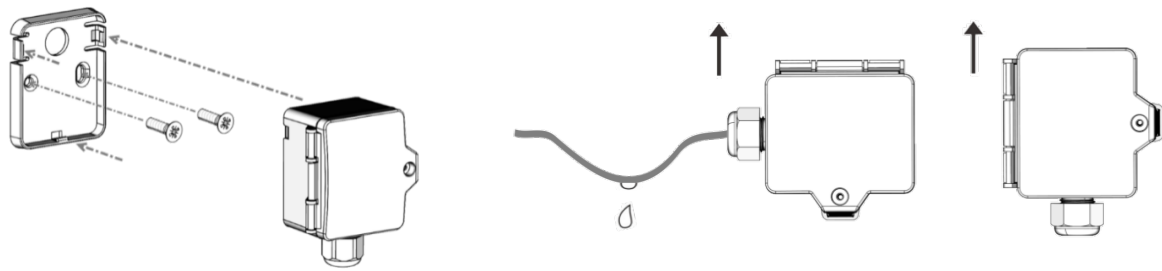





In case of outdoor installation avoid direct rain and sun contact. Cable entry from bottom or side. For side cable routing set loop so that precipitation can drain defined. Observe permissible ambient condition.

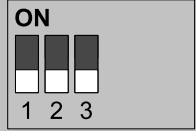

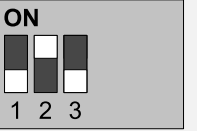
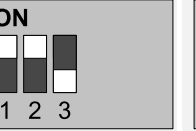
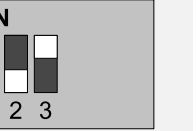
» CONNECTION PLAN

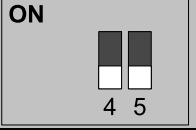
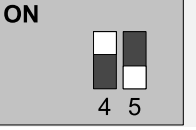
<p>LI65+ V</p> <p>n.c. AOU1 } (light 0..10 V) GND } (15..35 V = or 19..29 V ~) UB+ } 0.5 V 0..10 V</p>	<p>LI65+ A</p> <p>n.c. AOU1 } (light 0..10 V) GND } (15..35 V =) UB+ } n.c. AO11 } (light 4..20 mA) 0.5 V 0..10 V</p>
<p>LI65+ VV</p> <p>AOU2 } (temperature 0..10 V) AOU1 } (light 0..10 V) GND } (15..35 V = or 19..29 V ~) UB+ } 0.5 V 0..10 V</p>	<p>LI65+ AA</p> <p>AOU2 } (temperature 0..10 V) AOU1 } (light 0..10 V) GND } (15..35 V =) UB+ } AO12 } (temperature 4..20 mA) AO11 } (light 4..20 mA) 0.5 V 0..10 V</p>
<p>LI65+ 3xV</p> <p>AOU2 } (temperature 0..10 V) AOU1 } (light 0..10 V) GND } (15..35 V = or 19..29 V ~) UB+ } n.c. AOU3 } (humidity 0..10 V) 0.5 V 0..10 V</p>	<p>LI65+ 4xV</p> <p>AOU2 } (temperature 0..10 V) AOU1 } (light 0..10 V) GND } (15..35 V = or 19..29 V ~) UB+ } AOU4 } (atm. pressure 0..10 V) AOU3 } (humidity 0..10 V) 0.5 V 0..10 V</p>
<p>LI65+ VV Relay</p> <p>AOU2 } (temperature 0..10 V) AOU1 } (light 0..10 V) GND } (15..35 V = oder 19..29 V ~) UB+ } } (relay 2 NO) } (relay 1 NO)</p>	

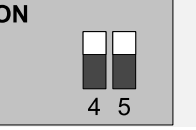
» DIP SWITCH CONFIGURATION

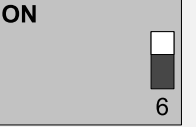
Measuring range light - DIP 1..3					
SI = 0..1 kLux * IMP = 0..100 fc 	SI = 0..0,2 kLux IMP = 0..20 fc 	SI = 0..2 kLux IMP = 0..200 fc 	SI = 0..10 kLux IMP = 0..1000 fc 	SI = 0..20 kLux IMP = 0..2000 fc 	SI = 0..50 kLux IMP = 0..5000 fc 
Measuring range temperature - DIP 4,5				System of units - DIP 6	
SI = -20..+80 °C * IMP = 0..+200 °F 	SI = 0..+50 °C IMP = +40..+140 °F 	SI = -40..+60 °C IMP = -40..+160 °F 	SI = -15..+35 °C IMP = 0..+100 °F 	SI * 	IMP 

» APPLICATION NOTICE



The Bluetooth dongle snaps into the socket easily. When removing, please fix the plug-in card (option PCB) so that it is not unintentionally pulled out.

» CONFIGURATION



The Thermokon bluetooth dongle with micro-USB is required for communication between USEapp and USE-M / USE L (Item No.: 668262). Commercial bluetooth dongles are not compatible.



Application-specific reconfiguration of the devices can be performed using the Thermokon USEapp. The configuration can be performed only when the device is powered.



The configuration-app and the app description can be found in the Google Play Store or in the Apple App Store.

» DIMENSIONS (MM)

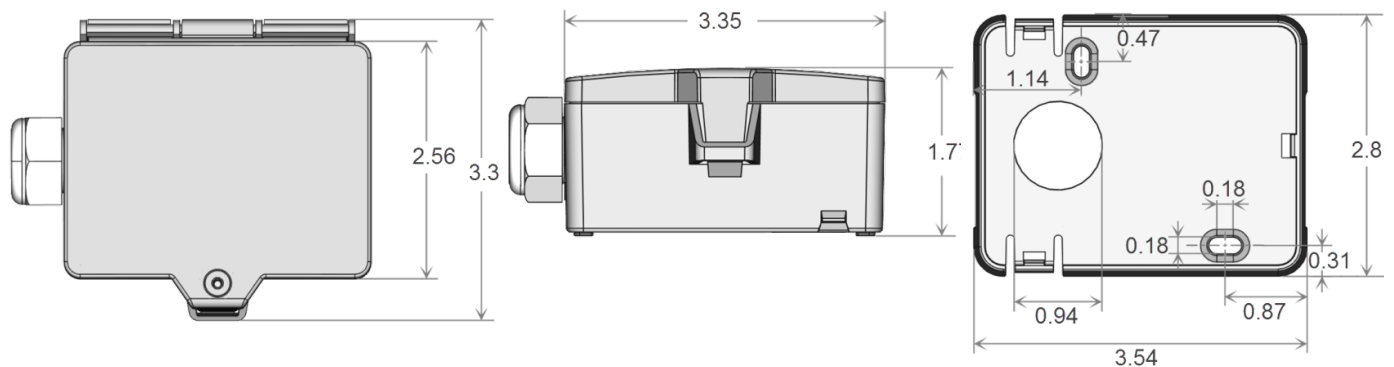

» ACCESSORIES (INCLUDED IN DELIVERY)

Mounting base
 Mounting kit universal
 • Cover screw + screw cover • 2 Rawplugs • 2 Screws (countersunk head) • 2 Screws (rounded head)

Item No. 631228
 Item No. 698511

» ACCESSORIES (OPTIONAL)

Bluetooth dongle
 Cable entry M25 USE white, sealing insert 4x Ø=0.28 in. (4 pcs)

Item No. 668262
 Item No. 641364